

Operating Instructions

VEGAMET 625

Double channel Hart signal conditioning instrument

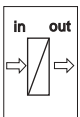

Contents

1	About this document	
1.1	Function	5
1.2	Target group	5
1.3	Symbolism used	5
2	For your safety	
2.1	Authorised personnel	6
2.2	Appropriate use	6
2.3	Warning about misuse	6
2.4	General safety instructions	6
2.5	CE conformity	6
2.6	Safety information for Ex areas	7
2.7	Environmental instructions	7
3	Product description	
3.1	Configuration	8
3.2	Principle of operation	9
3.3	Adjustment	9
3.4	Storage and transport	10
4	Mounting	
4.1	General instructions	11
4.2	Mounting information	11
5	Connecting to power supply	
5.1	Preparing the connection	13
5.2	Connection procedure	14
5.3	Wiring plans	16
6	Setup with the integrated indicating and adjustment unit	
6.1	Adjustment system	18
6.2	Setup procedure	19
6.3	Menu schematic	28
7	Setup with PACTware™	
7.1	Connecting the PC	38
7.2	Parameter adjustment with PACTware™	41
7.3	Setup web server/e-mail, remote enquiry	42
8	Application examples	
8.1	Interface measurement with VEGAFLEX 67	43
8.2	Flow measurement	44

9 Maintenance and fault rectification	
9.1 Maintenance	47
9.2 Fault rectification	47
9.3 Instrument repair	50
10 Dismounting	
10.1 Dismounting procedure	51
10.2 Disposal	51
11 Supplement	
11.1 Technical data.	52
11.2 Dimensions	56
11.3 Certificate	57

**Note:**

The operating instructions manual "RS232/Ethernet connection" as well as the additional instructions manual "Modbus-TCP, VEGA ASCII protocol" is attached to instructions with RS232/Ethernet interface. Here you will find further information for setup.

1 About this document

1.1 Function

This operating instructions manual has all the information you need for quick setup and safe operation of VEGAMET 625. Please read this manual before you start setup.

1.2 Target group

This operating instructions manual is directed to trained personnel. The contents of this manual should be made available to these personnel and put into practice by them.

1.3 Symbolism used



Information, tip, note

This symbol indicates helpful additional information.



Caution, warning, danger

This symbol informs you of a dangerous situation that could occur. Ignoring this cautionary note can impair the person and/or the instrument.



Ex applications

This symbol indicates special instructions for Ex applications.



List

The dot set in front indicates a list with no implied sequence.



Action

This arrow indicates a single action.



Sequence

Numbers set in front indicate successive steps in a procedure.

2 For your safety

2.1 Authorised personnel

All operations described in this operating instructions manual must be carried out only by trained specialist personnel authorised by the operator. For safety and warranty reasons, any internal work on the instruments must be carried out only by personnel authorised by the manufacturer.

2.2 Appropriate use

VEGAMET 625 is a universal signal conditioning instrument and power supply unit for connection of two HART sensors.

2.3 Warning about misuse

Inappropriate or incorrect use of the instrument can give rise to application-specific hazards, e.g. vessel overfill or damage to system components through incorrect mounting or adjustment.

2.4 General safety instructions

VEGAMET 625 is a high-tech instrument requiring the strict observance of standard regulations and guidelines. The user must take note of the safety instructions in this operating instructions manual, the country-specific installation standards (e.g. the VDE regulations in Germany) as well as all prevailing safety regulations and accident prevention rules.

2.5 CE conformity

VEGAMET 625 is in CE conformity with EMC (89/336/EWG) and NSR (73/23/EWG).

Conformity has been judged acc. to the following standards:

- EMC:
 - Emission EN 61326: 1997 (class A)
 - Susceptibility EN 61326: 1997/A1: 1998
- NSR: EN 61010-1: 2001

VEGAMET 625 is designed for use in an industrial environment. Nevertheless, electromagnetic interference from electrical conductors and radiated emissions must be taken into account, as is usual with a class A instrument acc. to

EN 61326. If VEGAMET 625 is used in a different environment, the electromagnetic compatibility to other instruments must be ensured by suitable measures.

2.6 Safety information for Ex areas

Please note the Ex-specific safety information for installation and operation in Ex areas. These safety instructions are part of the operating instructions manual and come with the Ex-approved instruments.

2.7 Environmental instructions

Protection of the environment is one of our most important duties. That is why we have introduced an environment management system with the goal of continuously improving company environmental protection. The environment management system is certified acc. to DIN EN ISO 14001.

Please help us fulfil this obligation by observing the environmental instructions in this manual:

- Chapter "*Storage and transport*"
- Chapter "*Disposal*"

3 Product description

3.1 Configuration

Scope of delivery

The scope of delivery encompasses:

- VEGAMET 625 signal conditioning instrument
- Socket
- Coded pins and bridges
- RS232 modem connection cable (optional)
- Documentation
 - this operating instructions manual
 - operating instructions manual "*RS232/Ethernet connection*" (optional)
 - Additional instruction manual "*Modbus-TCP, VEGA ASCII protocol*" (optional)
 - Ex-specific safety instructions (with Ex versions) and, if necessary, further certificates

Components

VEGAMET 625 consists of the following components:

- VEGAMET 625 signal conditioning instrument with indicating and adjustment unit in the front
- Communication interface for VEGACONNECT
- RS232 or Ethernet interface (optional)
- Socket

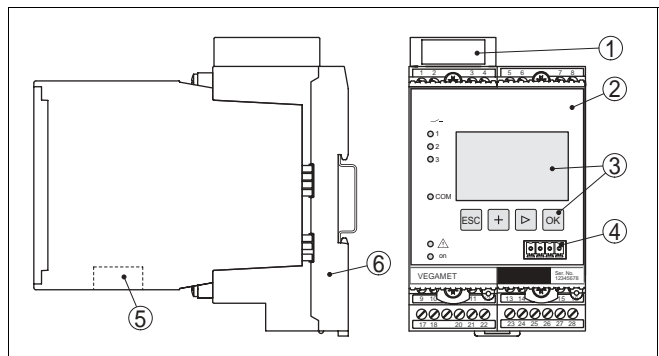

Fig. 1: VEGAMET 625

- 1 Ex separating chamber with Ex version
- 2 VEGAMET 625
- 3 Indicating and adjustment unit
- 4 Communication interface for VEGACONNECT (I²C)
- 5 RS232 or Ethernet interface (optional)
- 6 Socket

3.2 Principle of operation

Area of application

VEGAMET 625 is a universal signal conditioning instrument for a number of applications such as level, gauge, interface and process pressure measurement. At the same time, it can serve as power supply unit for connected sensors. VEGAMET 625 is designed for connection of two independent VEGA HART sensors. Hence two independent measurements can be carried out. By means of a third measurement loop, the difference between the two input values can be calculated.

With instruments with an optional interface (RS232/Ethernet) the measured values can be retrieved via modem or network and displayed by means of a web browser or Visual VEGA. It is also possible to send measured values and messages via e-mail.

Physical principle

VEGAMET 625 signal conditioning instrument can power the connected sensors and also evaluate their measuring signals. The requested parameter is indicated in the display and, in addition, outputted to the integrated current outputs for further processing. Hence the measuring signal can be transmitted to a remote display or a connected control system. In addition, three level relays for control of pumps or other actuators are integrated.

Power supply

Wide-range power supply unit with 20 ... 253 V AC/DC for world-wide use.

You can find detailed information on the power supply in the " *Technical data* " in the " *Supplement* ".

3.3 Adjustment

VEGAMET 625 can be adjusted with the following adjustment media:

- the integrated indicating and adjustment unit
- an adjustment software acc. to FDT/DTM standard, e.g. PACTware™ and a Windows PC

The entered parameters are generally saved in VEGAMET 625, when used with PACTware™ also optionally in the PC.



Information:

When PACTware™ and the corresponding VEGA-DTMs are used, additional settings can be made which are either not possible or partially restricted with the integrated indicating

and adjustment unit. If an adjustment software is used, you either need one of the integrated interfaces (RS232/Ethernet) or the interface converter VEGACONNECT.

Further instructions for setting up the web server and e-mail functions are stated in the online help of PACTware™ or the VEGAMET 625 DTM as well as the operating instructions manual "*RS232/Ethernet connection*".

3.4 Storage and transport

Packaging

Your instrument was protected by packaging during transport. Its capacity to handle normal loads during transport is assured by a test acc. to DIN EN 24180.

The packaging of standard instruments consists of environment-friendly, recyclable cardboard. For special versions PE foam or PE foil is also used. Dispose of the packaging material via specialised recycling companies.

Storage and transport temperature

- Storage and transport temperature see "*Supplement – Technical data – Ambient conditions*"
- Relative humidity 20 ... 85 %

4 Mounting

4.1 General instructions

Installation location

Each series 600 instrument consists of the actual signal conditioning instrument as well as a plug-in socket for carrier rail mounting. Because it has protection class IP 30 or IP 20, the instrument is intended to be used in switching cabinets.

4.2 Mounting information

Mounting

The plug-in socket is constructed for carrier rail mounting acc. to EN 50022. Power supply is connected to terminals 17 and 18. For neighbouring series 600 signal conditioning instruments, it is possible to continue connection L1 and N directly via the supplied bridges.



Danger:

The bridges must never be used with single instruments or at the end of a row of instruments. If this rule is not heeded, there is a danger of coming into contact with the operating voltage or causing a short circuit.



A VEGAMET 625 in Ex version is an auxiliary, intrinsically safe instrument and must not be installed in hazardous areas.

Before setup, the Ex separating chamber must be attached (as shown below) with Ex versions. Safe operation can be only ensured if the operating instructions manual and the EU type approval certificate are observed. VEGAMET 625 must not be opened.

Instrument coding

All signal conditioning instruments are provided with different gaps dependent on type and version (mechanical coding).

The plug-in socket is provided with coded pins that can be inserted to prevent accidental interchanging of the various instrument types.



With a VEGAMET 625 in Ex version, the supplied coded pins (type coded pin and Ex coded pin) must be inserted by the user acc. to the below chart.

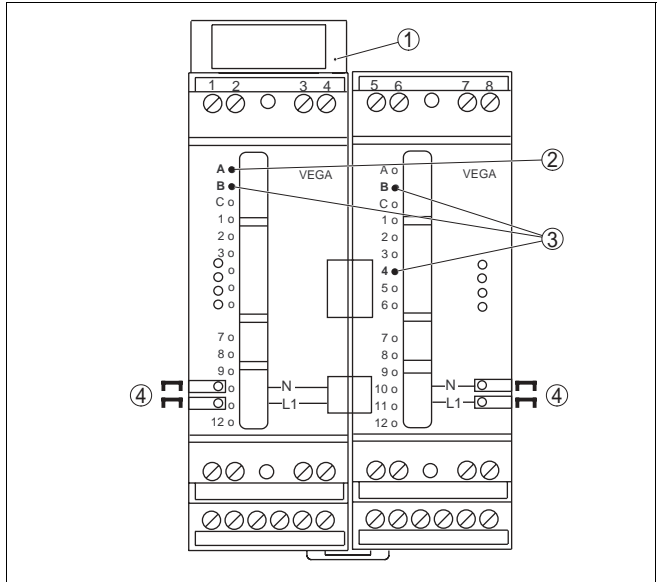

Fig. 2: Plug-in socket VEGAMET 625

- 1 Ex separating chamber
- 2 Ex coding with Ex version
- 3 Type coding for VEGAMET 624/625
- 4 Bridges for looping the power supply

5 Connecting to power supply

5.1 Preparing the connection

Note safety instructions

Always observe the following safety instructions:

- Connect only in the complete absence of line voltage
- If overvoltages are expected, overvoltage arresters should be installed.



Tip:

We recommend VEGA overvoltage arresters B61-300 (power supply VEGAMET 625) and B62-36G (sensor supply).

Take note of safety instructions for Ex applications



In hazardous areas you should take note of the appropriate regulations, conformity and type approval certificates of the sensors and power supply units.

Select power supply

The power supply can be 20 ... 253 V AC, 50/60 Hz.

Select connection cable

Power supply of VEGAMET 625 is connected with standard cable acc. to the national installation standards.

Standard two-wire cable with screening can be used for connecting the sensors. The screening is absolutely necessary to ensure interference-free operation with HART sensors.

Cable screening and grounding

Connect the cable screen on both ends to ground potential. In the sensor, the screen must be connected directly to the internal ground terminal. The ground terminal outside on the sensor housing must be connected to the potential equalisation.

If potential equalisation currents are expected, the screen connection on VEGAMET 625 must be made via a ceramic capacitor (e.g. 1 nF, 1500 V). The low frequency potential equalisation currents are thus suppressed, but the protective effect against high frequency interference signals remains.

Select connection cable for Ex applications



Take note of the corresponding installation regulations for Ex applications. In particular, make sure that no potential equalisation currents flow over the cable screen. In case of grounding on both sides this can be achieved by the use of a capacitor or a separate potential equalisation.

5.2 Connection procedure



Tip:

Before the actual setup, each HART sensors must be assigned an address (see chapter "*Setup*"). When assigning an address, only one sensor should be connected to VEGAMET 625. Depending on the installation location of the sensors, it can be advantageous to carry out this addressing before installing and connecting the sensors. This can be conveniently carried out e.g. in the workshop. You just need a 24 Volt power supply as well as an indicating and adjustment module PLICSCOM or the adjustment software PACTware™ with VEGACONNECT.

Move to electrical connection and proceed as follows:

- 1 Snap the socket without VEGAMET 625 onto the carrier rail
- 2 Connect sensor cable to terminal 1/2 (active input) or 3/4 (passive input), provide a screening
- 3 When using several sockets, loop the power supply by means of bridges
- 4 Connect power supply (switched off) to terminal 17 and 18
- 5 If necessary, connect relays or other outputs
- 6 Insert VEGAMET 625 into the plug-in socket and screw it down tightly

The electrical connection is finished.



Before setting up Ex versions, make sure the Ex separating chamber is plugged onto the left side of the housing (above the sensor terminals). The pins for type and Ex coding must also be inserted correctly.



Information:

- On the active input (terminals 1/2), VEGAMET 625 provides the power supply for the connected sensors. Power supply and measured value transmission are carried out via the same two-wire cable. This operating mode is intended for sensors without separate power supply (sensors in two-wire version).
- On the passive input (terminals 3/4), the sensors are not powered, only the measured value is transmitted. This input is for connection of transmitters with their own,

separate power supply (sensors in four-wire version). The connection and operation in Ex ia is not permitted on the passive input.

**Note:**

VEGAMET 625 is designed for connection of two HART sensors. Because they are accessed via different addresses in the HART multidrop mode, both sensors are connected to the same sensor input. These are either terminals 1/2 (active input) or terminals 3/4 (passive input). Simultaneous mixed operation on active and passive input is not possible. Because this is a digital bus system, only one two-wire cable should lead to the two sensors. A distributor can be connected directly in front of the sensors. As an alternative, the connection to the next sensor can be continued via the second cable entry in the sensor housing.

5.3 Wiring plans

Wiring plan for two-wire sensors

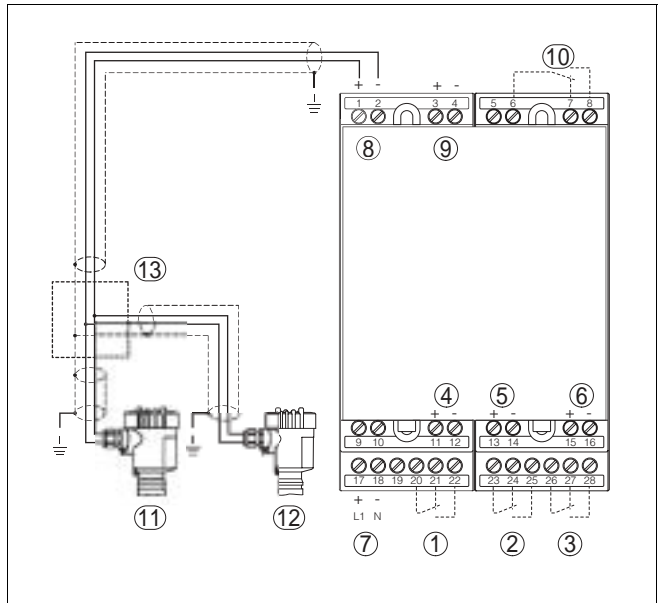

Fig. 3: Wiring plan VEGAMET 625 with two-wire sensors

- 1 Internal operating relay 1
- 2 Internal operating relay 2
- 3 Internal operating relay 3
- 4 Internal current output 1
- 5 Internal current output 2
- 6 Internal current output 3
- 7 Power supply of VEGAMET 625
- 8 Measured data input with sensor supply (active input)
- 9 Measured data input (passive input), not in Ex ia
- 10 Internal fail safe relay
- 11 HART two-wire sensor with Multidrop address 1
- 12 HART two-wire sensor with Multidrop address 2
- 13 Distributor

Wiring plan for four-wire sensors

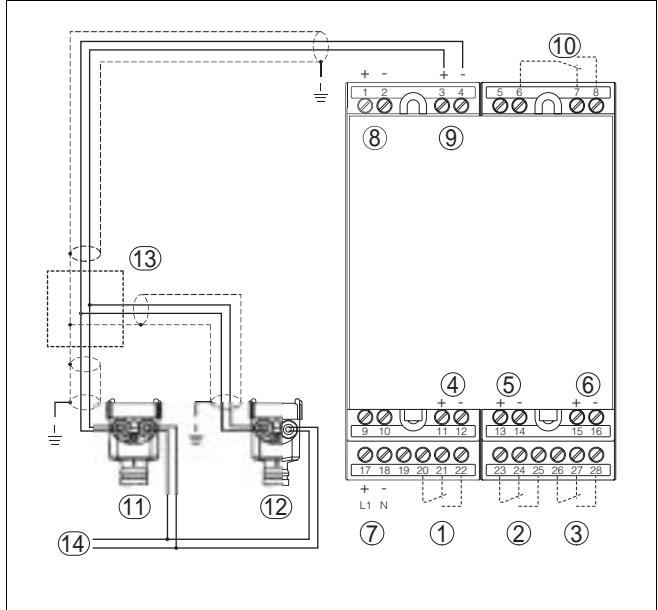

Fig. 4: Wiring plan VEGAMET 625 with four-wire sensors

- 1 Internal operating relay 1
- 2 Internal operating relay 2
- 3 Internal operating relay 3
- 4 Internal current output 1
- 5 Internal current output 2
- 6 Internal current output 3
- 7 Power supply of VEGAMET 625
- 8 Measured data input with sensor supply (active input)
- 9 Measured data input (passive input), not in Ex ia
- 10 Internal fail safe relay
- 11 HART four-wire sensor with Multidrop address 1
- 12 HART four-wire sensor with Multidrop address 2
- 13 Distributor
- 14 Power supply for four-wire sensors

6 Setup with the integrated indicating and adjustment unit

6.1 Adjustment system

Function

The integrated indicating and adjustment unit is used for measured value display, adjustment and diagnosis of VEGAMET 625 as well as the connected sensors. Indication and adjustment are made via four keys and a clear, graphic-capable indication with background lighting. The adjustment menu with language selection is clearly structured and enables easy setup.

Certain adjustment options are not possible or are partially restricted with the integrated indicating and adjustment unit, e. g. the settings for the e-mail server. For such applications, the use of PACTware™ with appropriate DTMs is recommended.

Indicating/Adjustment elements

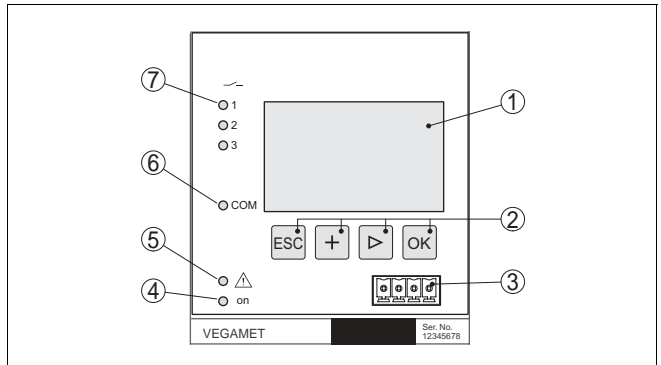

Fig. 5: Indicating and adjustment elements

- 1 LC display
- 2 Adjustment keys
- 3 Communication interface for VEGACONNECT
- 4 Status indication operation
- 5 Status indication fail safe relay
- 6 Status indication interface activity
- 7 Status indication operating relay 1-3

Key functions

- **[OK]** key:
 - move to the menu overview
 - confirm selected menu
 - edit parameter
 - save value
- **[-->]** key to select:
 - menu change
 - list entry

- editing position
- **[+]** key:
 - modify value of a parameter
- **[ESC]** key:
 - interrupt input
 - jump to the next higher menu

**Note:**

Approx. 10 minutes after the last pressing of a key, an automatic reset to measured value indication is triggered. Any values not confirmed with **[OK]** will not be saved.

6.2 Setup procedure

Set up

Setup encompasses mainly the selection of the application and the adjustment of the measurement loop. Scaling the measured value to the requested size and unit (possibly also applying a linearization curve), as well as the adaptation of the relay switching points, are additional settings. Further setup steps might be, if necessary, the modification of the current output characteristics or the setting of an integration time to smooth the measured value.

For instruments with Ethernet interface, the instrument must be provided with the host name and IP addr./Subnet mask. If necessary, the e-mail/web server can also be configured with PACTware™.

Set HART address

VEGAMET 625 can process measured values of several connected HART sensors. All measured values are transmitted as digital HART signals on the same cable (bus). Therefore an own, unique address (address range 1-15) must be assigned first of all to each connected sensor. This mode is also called HART Multidrop mode. Addressing can be done directly on each HART sensor via the respective adjustment unit or an appropriate adjustment software. As an alternative, the setting of the sensor address can be also carried out via the VEGAMET menu under "*Service – Sensor address*".

**Note:**

When addresses are being assigned, only one sensor with a particular address must be connected on the bus. If this is not the case, the sensor cannot be accessed and it is not possible to assign an address.

Switch on phase

After being switched on, VEGAMET 625 first of all carries out a short self-check. The following steps are carried out:

- Internal check of the electronics
- indication of the instrument type, firmware version as well as the instrument TAG (instrument name)
- the output signals jump briefly to the set fault current

Then the current measured values will be displayed and outputted.

**Measured value indication/
Main menu**

As requested, the measured value display shows the individual measurement loops separately or in a joint overview. The respective digital display value, the measurement loop designation (meas. loop TAG) and the unit are shown. With the separate presentation, an analogue bar graph is also displayed and the measured values appear in bigger font size.

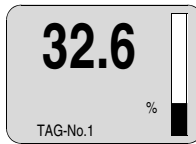

By pushing **[OK]** you move from the measured value indication to the main menu.

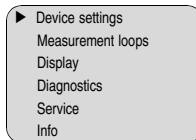

With the initial setup, you should select all submenu items of "Device settings" and enter the correct settings.

➔ Select the menu item *Device settings* with **[->]** and confirm with **[OK]**.

Device settings – Application

Under the menu item "Device settings", you can select the requested application. For all level, gauge and differential measurements, the application "Standard" is correct.

If an interface measurement should be carried out with a VEGAFLEX 67, you have to choose the menu item "Interface measurement" as application. After the configuration of the inputs, the exact DK value for the upper medium must be entered. For further information see chapter "Application examples".

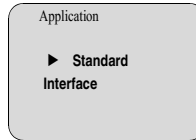

→ Select the requested application with **[→]** and save your settings with **[OK]**. Then move to the menu item **Input** with **[→]**.

Device settings – Input

Because VEGAMET 625 has two inputs, the measurement loops must be assigned to the inputs. After the addresses of the HART sensors are assigned, a list with the existing sensors can be prepared and displayed via "*Sensor selection – Sensor search*". Now you can assign the requested sensor to each measurement loop.

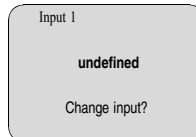

VEGAMET 625 must be informed which "*Sensor value*" für die Weiterverarbeitung verwendet werden soll. Je nach Sensortyp kann dies Distanz, Druck, Trennschicht oder Temperatur sein. Beim Anschluss von HART-Sensoren anderer Hersteller stehen unter anderem die Auswahlmöglichkeiten PV (Primary Value) und SV (Secondary Value) zur Verfügung. Welche Messgröße hierbei übertragen wird, muss aus der Betriebsanleitung des jeweiligen Sensorherstellers entnommen werden.

→ Allocate the requested inputs to the appropriate measurement loops, select the suitable sensor value and save your settings with **[OK]**. After the first setup, you can modify the inputs als under "*Meas. loop – Input*".

Device settings – Device-TAG

You can assign an unambiguous name to VEGAMET 625 via the Device-TAG. This function is recommended when several VEGAMETs are implemented and a good documentation of larger system is required.

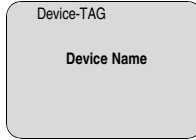

→ Enter the requested values via the appropriate keys and save your settings with **[OK]**.

Device settings – Host Name/ IP address

For instruments with integrated Ethernet interface also a host name and the IP address must Subnet Mask for integration in the network must be entered. These specifications are available from your network administrator. These settings are only effective after a restart of VEGAMET 625.

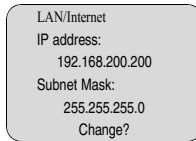

→ Enter the values via the appropriate keys and save your settings with **[OK]**. Disconnect briefly the supply voltage so that the modified settings become effective.

Device settings – Time/Date

On instruments with integrated RS232/Ethernet interface, the date and time can be entered in this menu item. These time settings are buffered for approx. 3 days in case of power loss.



→ Enter the values via the appropriate keys and save your settings with **[OK]**.

Meas. loop - Input

Because VEGAMET 625 has two inputs, the measurement loops must be assigned to the inputs. After the addresses of the HART sensors are assigned, a list of the existing sensors can be prepared and displayed via the sensor search. Now you can assign the requested sensor to each measurement loop.

VEGAMET 625 must be informed which "Sensor value" für die Weiterverarbeitung verwendet werden soll. Je nach Sensortyp kann dies Distanz, Druck, Trennschicht oder Temperatur sein.

Beim Anschluss von HART-Sensoren anderer Hersteller stehen unter anderem die Auswahlmöglichkeiten PV (Primary Value) und SV (Secondary Value) zur Verfügung. Welche Messgröße hierbei übertragen wird, muss aus der Betriebsanleitung des jeweiligen Sensorherstellers entnommen werden.

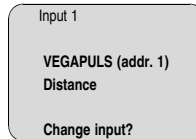

Meas. loop – Parameter

Via the parameter you inform VEGAMET 625 of the type of measurement. The following options are available:

- Level
- Process pressure (only with VEGABAR, VEGAWELL, D-series)
- Temperature (only with VEGABAR, VEGAWELL)
- Difference (only with measurement loop 3)
- Interface (only with VEGAFLEX 67)
- Universal (for sensors of other manufacturers)

The third measurement loop is always a differential measurement loop calculating the difference of the values of measurement loops 1 and 2 (optionally measurement loop 1-2 or 2-1).

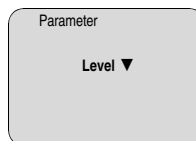

Information:

Keep in mind that some settings must be carried out individually several times, because they are specifically required for each measurement loop. This applies e.g. to the single measurement loops, the displayed values in the display as well as the relay and current outputs.

Meas. loop – Adjustment

The unit of measurement must be selected before starting the adjustment. Depending on the connected instrument this can be e.g. m(d), ft(d), bar, psi, °C or %.

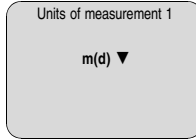

The following illustrations and examples relate to the min./max. adjustment of a radar sensor.

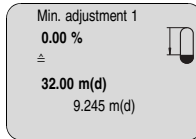

- With **[OK]** you prepare the percentage value for editing, with **[->]** you set the cursor to the requested position. Set the requested percentage value with **[+]** and save with **[OK]**. The cursor jumps now to the distance value.
- Enter now the appropriate distance value in m [m(d)] (corresponding to the percentage value) for the empty vessel (e.g. distance from the sensor to the vessel bottom).
- Save the settings with **[OK]** and move to "Max. adjustment" with **[->]**.

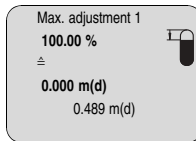

- As previously described, enter now the percentage value for the max. adjustment and confirm with **[OK]**.
- Enter now the appropriate distance value in m [m(d)] (corresponding to the percentage value) for the full vessel. Keep in mind that the max. level must be below the radar antenna.
- Finally save your settings with **[OK]**, the adjustment is finished.

Meas. loop – Damping

To suppress fluctuation in the measured value display, e.g. caused by an agitated product surface, an integration time can be set. This time can be between 0 and 999 seconds. Keep in mind, that this setting will increase the reaction time of the

measurement and that the reaction to quick changes of the measured value will be delayed. In general, a time of a few seconds is sufficient to smooth the measured value display.

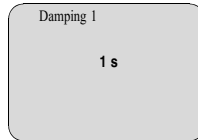

→ Enter the requested parameter via the appropriate keys and save your settings with **[OK]**.

Meas. loop – Linearization curve

A linearization is necessary for all vessels in which the vessel volume does not increase linearly with the level, e.g. with a cylindrical or spherical tank. Corresponding linearization curves are preprogrammed for these vessels. They represent the correlation between the level percentage and vessel volume. By activating the appropriate curve, the volume percentage of the vessel is displayed correctly. If the volume should not be displayed in percent but e.g. in l or kg, a scaling can be also set.

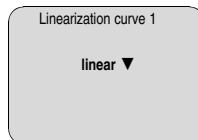

→ Enter the requested parameter via the appropriate keys and save your settings with **[OK]**.

Meas. loop – Scaling

Scaling is the conversion of the measured value into a certain parameter or measuring unit. Instead of the percentage value, the volume can be displayed, e.g. in l. Indicating values between max. -99999 and +99999 are possible.

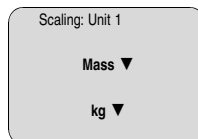

→ Enter the requested parameter via the appropriate keys and save your settings with **[OK]**.

Meas. loop – Meas. loop TAG

In this menu item you can enter an unambiguous designation for each measurement loop, e.g. the measurement loop name or the tank or product designation. In digital systems and in the documentation of larger plants, a unique designation should be entered for exact identification of individual measuring sites.

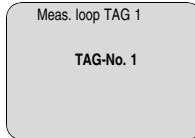

→ Enter the requested parameter via the appropriate keys and save your settings with **[OK]**.

Meas. loop – Outputs – Relay outputs

Under "Outputs" you will find the relay and current outputs. With relay output, first of all the requested mode ("*Overfill protection*" or "*Dry running protection*") must be selected.

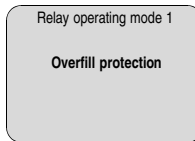

→ Enter now the switching points for switching the relay on and off. The parameter to which they refer can also be selected.

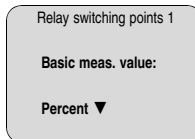

In the following window the reaction of the relay in case of failure can be determined. Here you can define whether, in case of failure, the switching condition of the relay remains unchanged or the relay is switched off.

Meas. loop – Outputs – Current outputs

The characteristics of the current outputs can be set to 0 ... 20 mA, 4 ... 20 mA or inverted. The reaction in case of failure can be also adapted to the requirements. The parameter to which they refer can also be selected.

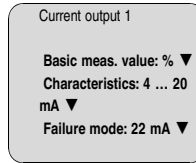

→ Enter the requested parameter via the appropriate keys and save your settings with **[OK]**.

Display

In the menu item "*Display*", you can set the requested displayed value for the measurement loop.

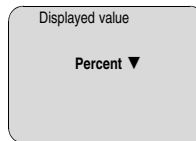

→ Enter the requested parameter via the appropriate keys and save your settings with **[OK]**.

Diagnostics

If the instrument displays a fault, further information can be retrieved via the menu item "*Diagnostics – Device status – Add. information*".

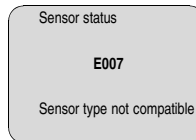

Service

The service menu contains the following settings:

- Simulation of the measured value
- Reset
- Set display language
- PIN to block the menu
- Change HART sensor address

→ Enter the requested parameter via the appropriate keys and save your settings with **[OK]**.

Service – Change sensor address

Under this menu item you can assign and modify the HART addresses of the connected sensors.

**Note:**

When addresses are being assigned, only one sensor with a particular address must be connected on the bus. If this is not the case, the sensor cannot be accessed and it is not possible to assign an address.

Set the current HART address of the requested sensor in the menu item "*Previous address*". The default setting of all supplied VEGA sensors is always **00**. After pushing the *[->]* key, you can assign the requested HART address in the range of 01 – 15 in the menu "*New address*". Make sure that no address is assigned twice.

Sensor address

New address:

01

Info

In the menu item "Info" the following information is available:

- Sensor type and serial number
- Date of manufacture and software version
- Date of last change using PC
- Details of VEGAMET 625
- MAC address (with interface option Ethernet)

Further settings

Additional adjustment and diagnostics options are available via the Windows software PACTware™ and the suitable DTM. Connection can be made via the interface converter VEGA-CONNECT or RS232/Ethernet (depending on the instrument version). Further information is available in chapter "*Parameter adjustment with PACTware™*", in the online help of PACTware™ or the DTM as well as in the operating instructions manual "*RS232/Ethernet connection*".

6.3 Menu schematic



Note:

The operating instructions manual "RS232/Ethernet connection" as well as the additional instructions manual "Modbus-TCP, VEGA ASCII protocol" is attached to instructions with RS232/Ethernet interface. Here you will find further information for setup.

Device settings

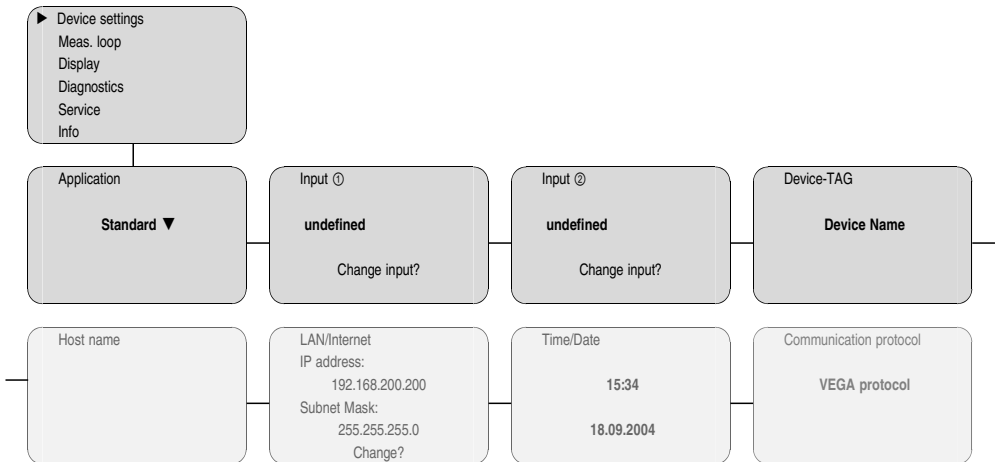

Meas. loop 1 and 2 – Input

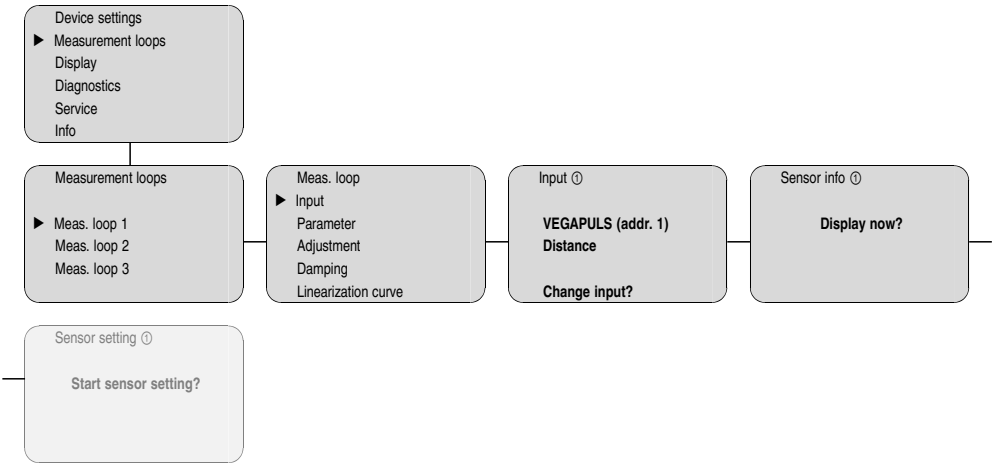

Meas. loop 1 and 2 – Change input

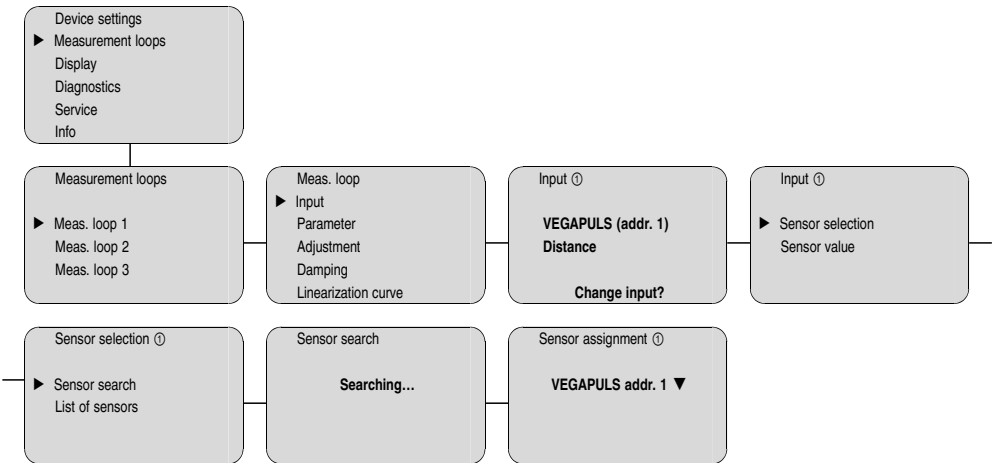

Meas. loop 3 – Change input

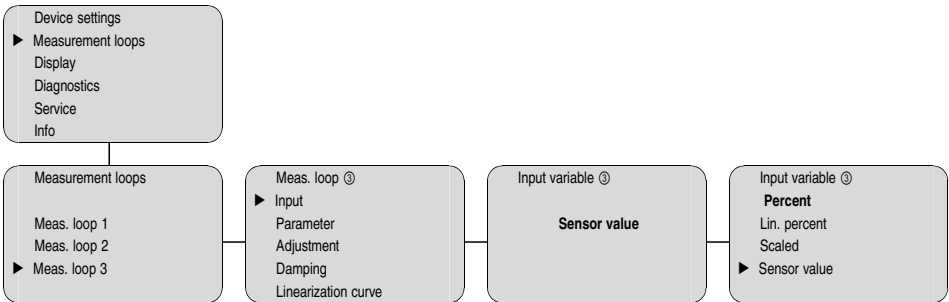

Meas. loop 1 and 2 – Parameter

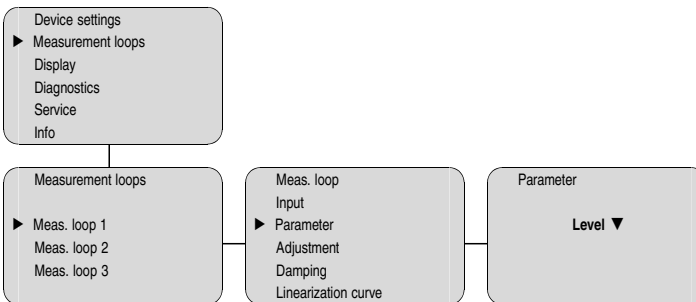

Meas. loop 3 – Parameter

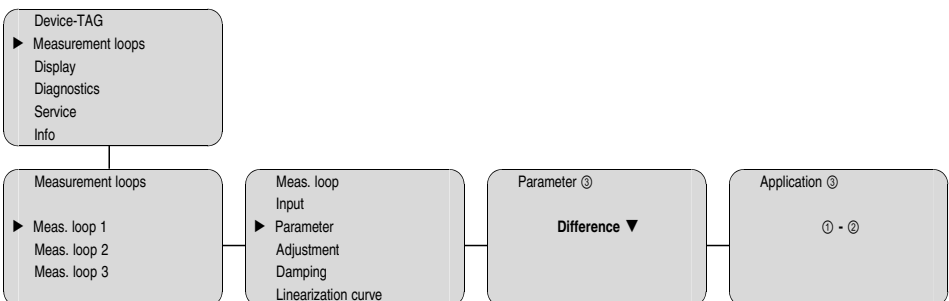

Meas. loop – Adjustment

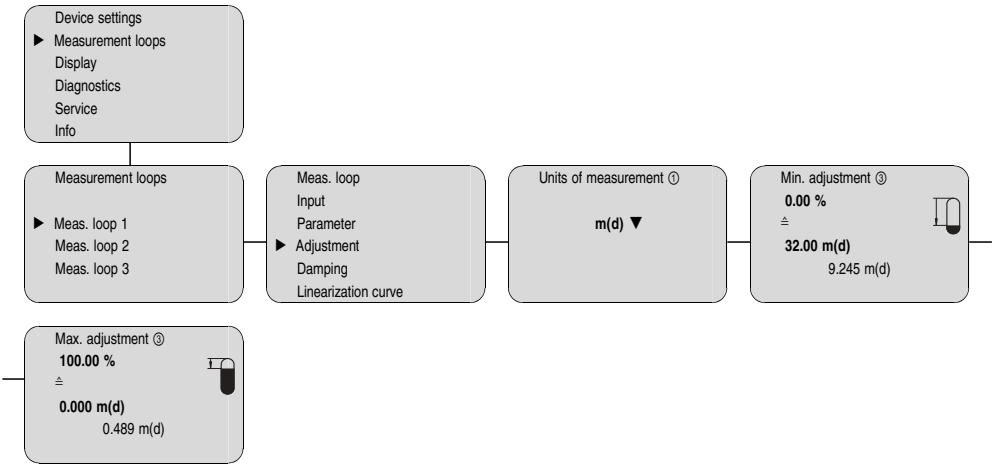

Meas. loop – Damping

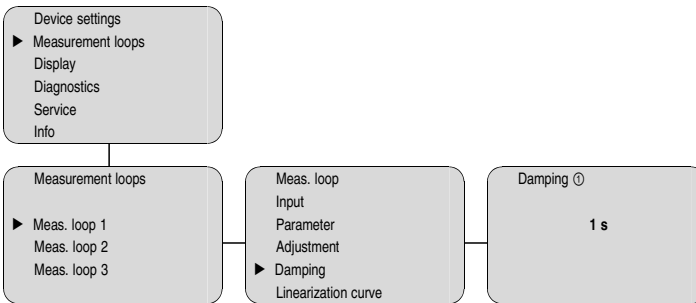

Meas. loop – Linearization curve

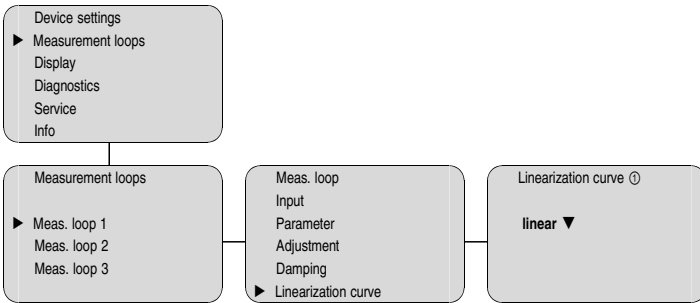

Meas. loop – Scaling

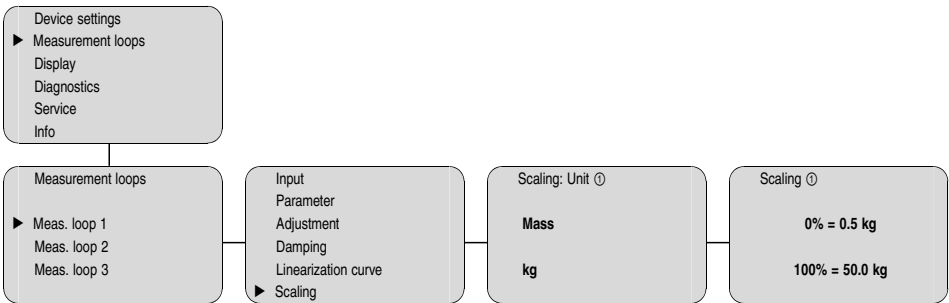

Meas. loop – Meas. loop TAG

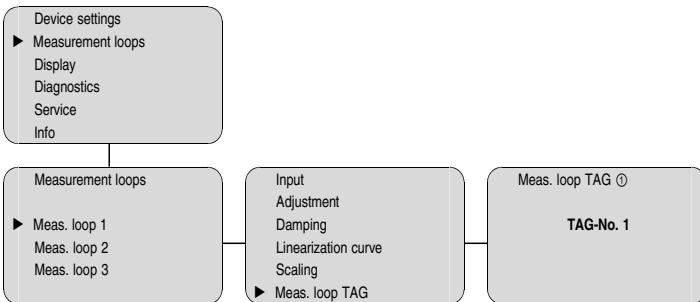

Meas. loop – Output – Relay

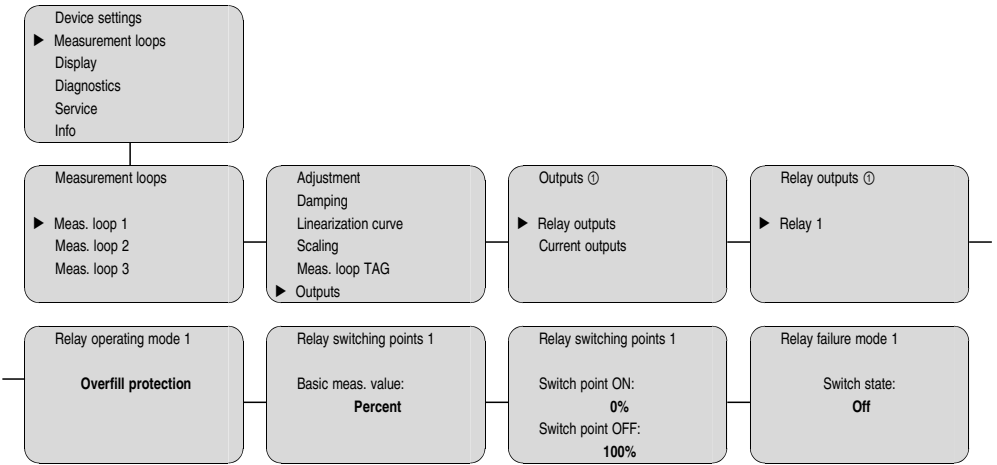

Meas. loop – Outputs – Current outputs

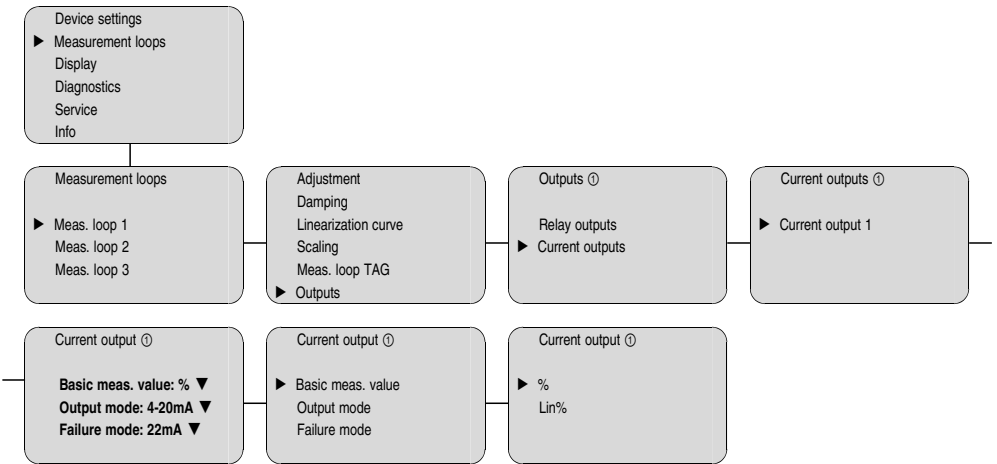

Display

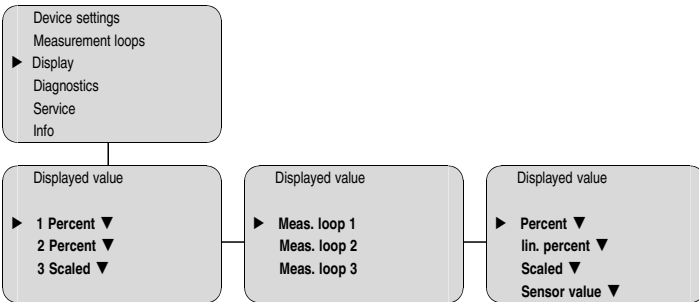

Diagnostics

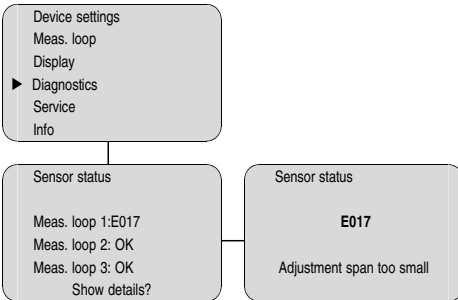

Service

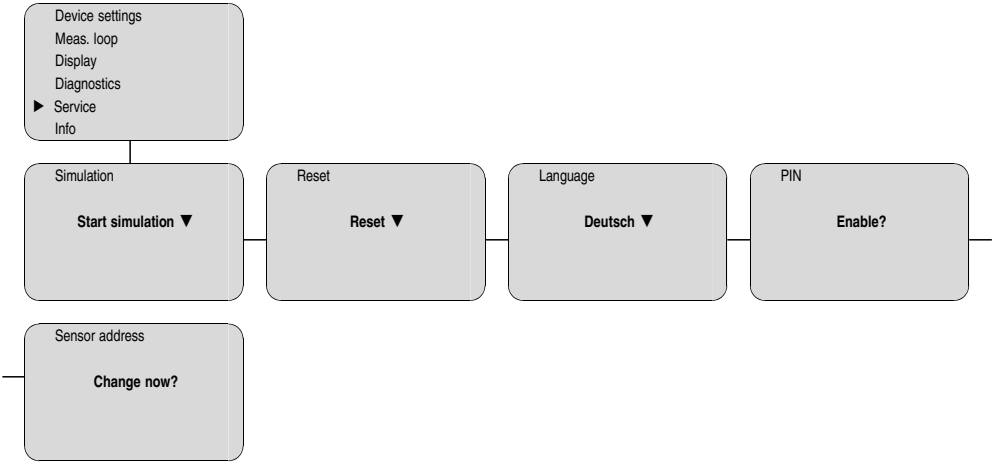

Service – Simulation

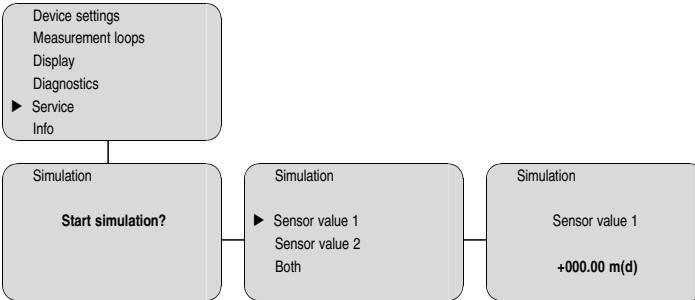

Service – Sensor address

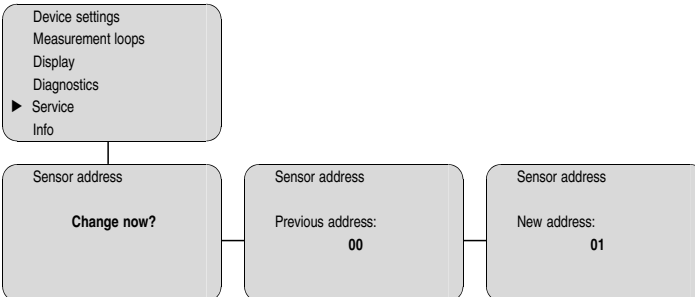

Info

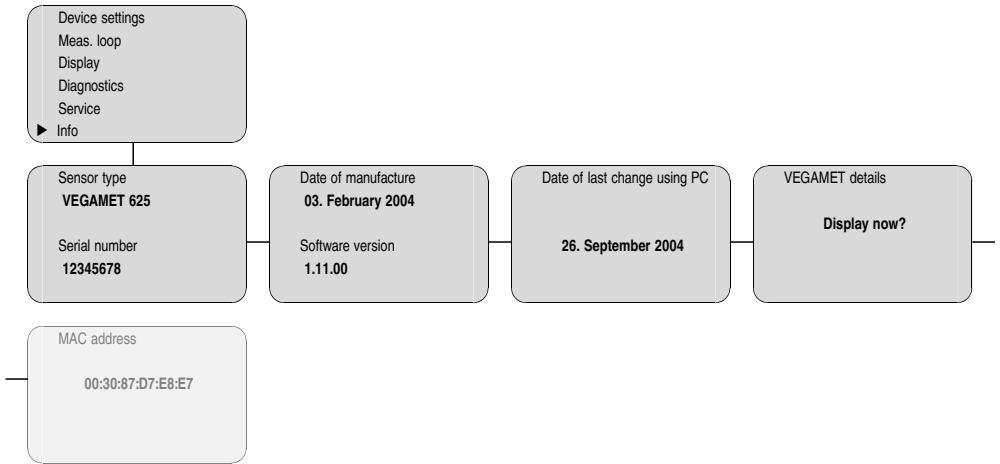

7 Setup with PACTware™

7.1 Connecting the PC

Connecting the PC via VEGA-CONNECT

For temporary connection of the PC, e.g. for parameter adjustment, the connection can be made via the interface converter VEGACONNECT. The necessary I²C interface in the front of VEGAMET 625 is available with all instrument versions. On the computer, connection is made via the RS232 interface. If this is not available on your PC or already occupied, it is also possible to use a USB – RS232 adapter (e.g. article no. 2.26900).

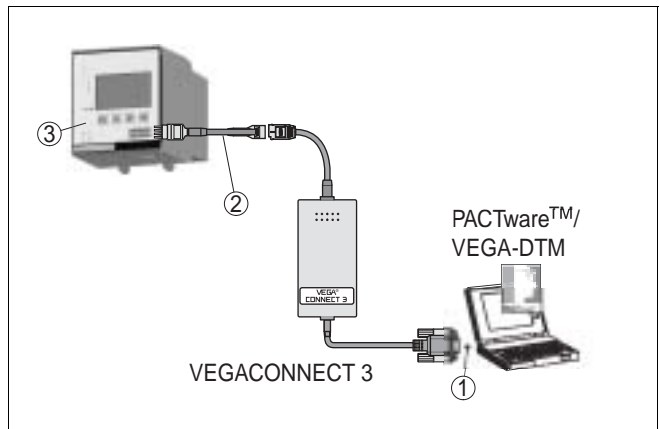

Fig. 6: Connection via VEGACONNECT

- 1 RS232 interface of the PC
- 2 I²C adapter cable for VEGACONNECT 3 (article no. 2.27323)
- 3 VEGAMET 625

Connection of the PC via RS232

Via the RS232 interface, direct parameter adjustment and measured value enquiry of the instrument can be carried out via PACTware™. Use the RS232 modem connection cable that is supplied with the instrument and an additionally connected interlink cable (e.g. article no. LOG571.17347). To reduce EMC interference, you should mount the supplied ferrite bead on the RS232 modem connection cable.

If there is no RS232 interface on the PC or if the interface is already occupied, it is also possible to use a USB – RS232 adapter (e.g. article no. 2.26900).

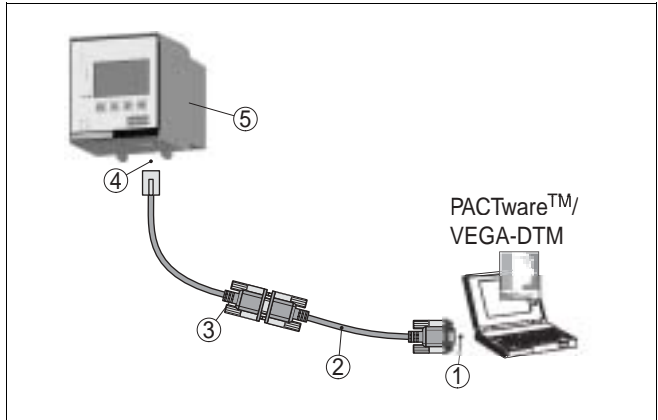

Fig. 7: Connection of the PC via RS232

- 1 RS232 interface of the PC
- 2 RS232 interlink cable (article no. LOG571.17347)
- 3 RS232 modem connection cable (in the scope of delivery)
- 4 RS232 interface of VEGAMET 625
- 5 VEGAMET 625

Connection of the modem via RS232

The RS232 interface is particularly suitable for easy modem connection. For this purpose, external analogue, ISDN and GSM modems with standard interface can be used. The necessary RS232 modem connection cable is supplied with VEGAMET 625. To reduce EMC interference, you should mount the supplied ferrite bead on the RS232 modem connection cable. Remote enquiry and processing of the measured values is now possible via the software "Visual VEGA". Alternatively, independent, time or event-controlled transmission of measured values via e-mail is also possible. In addition, a remote parameter adjustment of VEGAMET 625 and the connected sensors is possible with PACTware™.

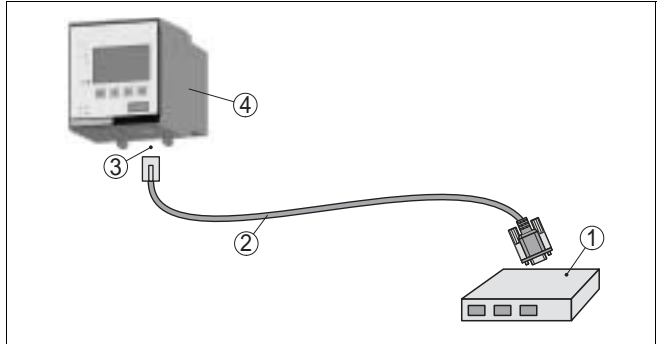

Fig. 8: Connection of the modem via RS232

- 1 Analogue, ISDN or GSM modem with RS232 interface
- 2 RS232 modem connection cable (in the scope of delivery)
- 3 RS232 interface of VEGAMET 625
- 4 VEGAMET 625

Connection of the PC via Ethernet

With the Ethernet interface, VEGAMET 625 can be connected directly to an existing PC network. Any standard patch cable can be used. When connecting a VEGAMET 625 directly to the PC, a cross-over cable must be used. To reduce EMC interference, you should mount the supplied ferrite bead on the Ethernet connection cable. Each VEGAMET 625 then gets its own IP address under which it can be accessed from anywhere in the network. The parameter adjustment of the instrument via PACTware™ can be carried out from any PC. The measured values can be made available to individual users within the company network as HTML chart. Alternatively, independent, time or event-controlled transmission of measured values via e-mail is also possible.

For more comprehensive requirements, we recommend using the software "Visual VEGA" for measured value enquiry and visualisation.



Note:

To adjust with PACTware™ and DTM, a suitable IP address must be available in the instrument. Each instrument is preset to address 192.168.200.200. Enter the address and subnet mask corresponding to your network directly via the keyboard. Briefly interrupt the power supply, then the instrument is accessible via its IP address everywhere in the network. In addition, this information must be entered in the DTM (see chapter "Parameter adjustment with PACTware™").

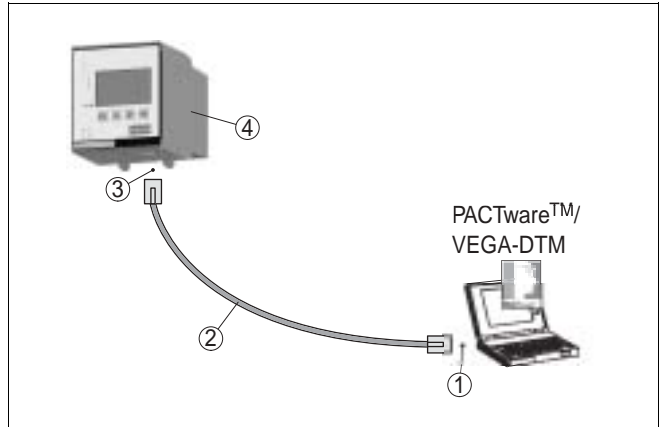

Fig. 9: Connection of the PC via Ethernet

- 1 Ethernet interface of the PC
- 2 Ethernet connection cable (patch cable)
- 3 Ethernet interface of VEGAMET 625
- 4 VEGAMET 625

7.2 Parameter adjustment with PACTware™

VEGAMET 625 signal conditioning instrument can be operated via a Windows PC. You will need the configuration software PACTware™ and a suitable instrument driver (DTM) acc. to the FDT standard. In addition, the VEGA DTMs can be integrated in other frame applications acc. to FDT standard. For connection either the interface converter VEGACONNECT or one of the offered interfaces (Ethernet/RS232) in VEGAMET 625 is required. Not only VEGAMET 625 itself, but also connected VEGA HART sensors can be accessed.

When connecting via Ethernet, VEGAMET 625 must be provided with a suitable IP address and subnet mask. This information must be entered additionally in the DTM. Click in the project window with the right mouse key to the VEGA Ethernet DTM and choose "Add. functions – Modify DTM addresses").



Note:

Connection of VEGACONNECT or a HART modem directly to the 4 ... 20 mA sensor cable is not possible.

All currently available VEGA DTMs are combined under the name "DTM Collection" with the current PACTware™ version on CD. They are available from the responsible VEGA agency

for a token fee. The basic version of this DTM Collection incl. PACTware™ is available as a free-of charge download from our homepage "www.vega.com".

The professional version also includes saving and printing of project documentation. A DTM licence for the appropriate instrument family can be purchased from the responsible VEGA agency.

Further setup steps are described in the operating instructions manual "*DTM-Collection/PACTware™*" attached to each CD and which can also be downloaded from the Internet. A detailed description is available in the online help of PACTware™ and the VEGA DTMs as well as in the operating instructions manual "*RS232/Ethernet connection*".



Information:

Keep in mind that for setup of VEGAMET 625, DTM-Collection 04/2004 or a newer version must be used.

7.3 Setup web server/e-mail, remote enquiry

The setup and application examples of the web server, e-mail functions as well as Modbus TCP are listed in the separate operating instructions manual "*RS232/Ethernet connection*". This manual is attached to each instrument with RS232 or Ethernet interface. There you will also find the visualisation and remote enquiry with the "*Visual VEGA*" software.

8 Application examples

8.1 Interface measurement with VEGAFLEX 67

In an interface measurement, there are two different media which do not mix, e.g. water and oil or solvents. To detect the volume of both products, it is necessary to detect the height of the upper liquid (level) and the interface between the two products. A VEGAFLEX 67 is necessary as a transmitter which delivers the distance to the upper medium as well as the distance to the interface. Via the adjustment in VEGAMET 625 the level, interface and layer thickness of the upper medium can be calculated and displayed.

The following steps are necessary:

- **Selection of the application**
 - Select under "*Device settings – Application*" the entry "*Interface measurement*" and confirm with **[OK]**. Via the **[->]** key you reach the next step.
- **Assignment of the inputs and measurement loops**
 - Select "*Input – Change input*". Now an automatic sensor search is started and, if there is a proper connection, VEGAFLEX 67 will be displayed. Accept the settings with **[OK]** and move to the DK value input with **[->]**. The input variables are automatically assigned to the following measurement loops:
 - Meas. loop 1: Interface (level of the lower medium)
 - Meas. loop 2: Level (total level of both products)
 - Meas. loop 3: Layer thickness (thickness of the upper medium)
- **Input of the DK value**
 - Enter the exact DK value of the upper medium. For further information on the DK value, see the operating instructions manual of VEGAFLEX 67.
- **Adjustment**
 - Each VEGAFLEX 67 is supplied with default settings. The values of this adjustment are automatically transferred to VEGAMET 625 when creating an interface measurement. Normally, a manual adjustment is not necessary. Should the instrument get a special adjustment, this adjustment can be carried out under "*Meas. loops – Adjustment*". Keep in mind that this adjustment must be carried out for all three measurement loops separately.

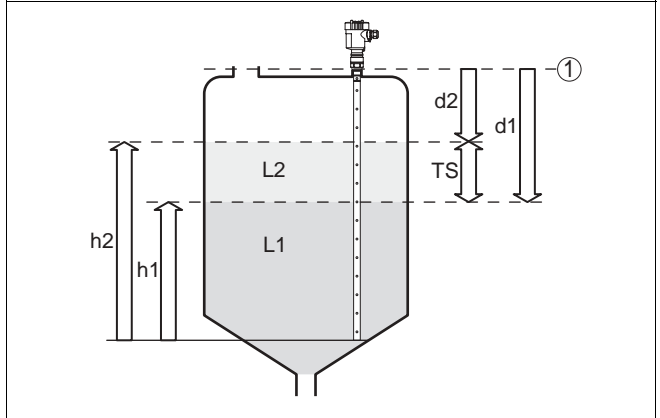

Fig. 10: Interface measurement

1 Reference plane

d1 Distance to the interface, meas. loop 1

d2 Distance to the level, meas. loop 2

TS Thickness of the upper medium ($d1-d2$), meas. loop 3 (displayed value)

h1 Height - Interface (displayed value)

h2 Height - Level (displayed value)

L1 Lower medium

L2 Upper medium

8.2 Flow measurement

Physical principle

For flow measurement in open flumes, a contraction or standardised flume must be used. Depending on the flow volume, this contraction generates a certain backwater. The flow can be determined from the height of this backwater. The flow volume is outputted by an appropriate number of pulses on the relay or current output.

Flume

Depending on the type and version, each flume generates a different backwater. The data of the following flumes are available in the instrument:

- Palmer-Bowlus-Flume
- Venturi flume, trapezoidal weir, rectangular weir
- V-Notch

Setup

The configuration of the flow measurement loop requires PACTware™ with the suitable DTMs. The example refers to a flow measurement with a radar sensor. The following setup steps must be carried out:

- Selection of the parameter "Flow"
- Carrying out adjustment

- Select flume (Linearization)
- Set scaling
- Parameter adjustment of pulse outputs

Parameter – Flow

Select in the DTM window "*Parameter*" the option "*Flow*" with the requested unit of measurement.

Adjustment

Min. adjustment: Enter the suitable value for 0 %, i.e. the distance from the sensor to the medium as long as there is no flow. These are in the following example 1.40 m.

Max. adjustment: Enter the suitable value for 100 %, i.e. the distance from the sensor to the medium, with the max. flow volume. This is in the following example 0.80 m.

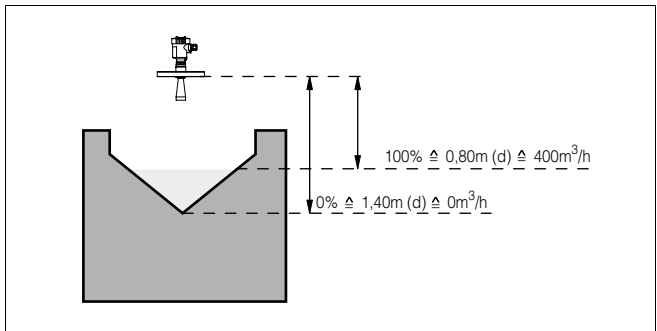

Fig. 11: Adjustment flow measurement with V-notch

Linearization curve

Select in the DTM window "*Linearization*" the option "*Flow*" and then the used flume (in the above example V-notch).

Scaling

Select in the DTM window "*Scaling*" under "*Parameter*" the option "*Flow*". Finally the allocation of a value must be carried out, i.e. the flow volume is assigned to the 0 and 100 % value. As the last step, select the requested meas. unit. For above example: 0 % = 0 and 100 % = 400, meas. unit m³/h.

Outputs

First of all decide if you want to use a relay and/or a current output. In the DTM window "*Outputs*" you can use any of the three outputs as long as these are not yet used for other tasks.

Finally select under "*Mode*" (relay) or "*Output characteristics*" (current output) the option "*Flow volume pulse*" or "*Sampling pulse*". Enter under "*Pulse output all*" the flow volume after which a pulse should be outputted (e.g. 400 m³ corresponds to one pulse per hour with a flow volume of 400 m³/h).

In mode "*Sampling pulse*" an additional pulse is outputted after a defined time. This means that a timer is started after each pulse after which another pulse is outputted. This applies only if already a pulse was outputted after exceeding the flow volume.

Due to sludge at the bottom of the flume, it can happen that the min. adjustment originally carried out can no longer be reached. Therefore small quantities will continuously enter the flow volume detection despite the "empty" flume. The option "*Min. flow volume suppression*" offers the possibility to suppress measured flow volumes below a certain percentage value for the flow volume detection.

9 Maintenance and fault rectification

9.1 Maintenance

When used as directed in normal operation, VEGAMET 625 is completely maintenance-free.

9.2 Fault rectification

Causes of malfunction

VEGAMET 625 offers maximum reliability. Nevertheless faults can occur during operation. These may be caused by the following, e.g.:

- Measured value of the sensor not correct
- Power supply
- Interference on the cables

Fault rectification

The first measures to be taken are to check the input/output signals as well as to evaluate the error messages via the display. The procedure is described below. Further comprehensive diagnostics can be carried out on a PC with the software PACTware™ and the suitable DTM. In many cases, the causes can be determined in this way and faults can be rectified.

24 hour service hotline

Should these measures not be successful, please call in urgent cases the VEGA service hotline under the phone number **+49 1805 858550**.

The hotline is available to you 7 days a week round-the-clock. Since we offer this service world-wide, the support is only available in the English language. The service is free of charge, only the standard telephone costs will be charged.

Fault messages

? E003

- CRC-error
- Carry out a reset
- Return instrument for repair

? E007

- Sensor type not compatible
- Search for the sensor and allocate it under "*Meas. loop - Input*"

- ? E008
- Sensor not found
 - Check connection of the sensor
 - Check HART address of the sensor
- ? E013
- Sensor signals failure/no valid measured value
 - Check sensor parameter adjustment
 - Return sensor for repair
- ? E016
- Empty/full adjustment reversed
 - Carry out a fresh adjustment
- ? E017
- Adjustment span too small
 - Carry out a fresh adjustment and increase the distance between min. and max. adjustment
- ? E021
- Scaling span too small
 - Carry out a fresh scaling, increase the distance between min. and max. scaling.
- ? E026
- Units of the input variable are different (only differential measurement loop)
 - Adapt the units of both
 - Use sensors with the same input variable

? E030

- Invalid measured value
- Check sensor parameter adjustment

? E034

- EEPROM defective
- Carry out a reset
- Return instrument for repair

? E035

- EEPROM CRC-error
- Carry out a reset
- Return instrument for repair

? E036

- Instrument software not executable (during software update or after failed update)
- wait until software update is finished
- Carry out another software update

? E053

- Sensor measuring range not read correctly
- HART communication error: Check sensor cable and screening

? E062

- Pulse priority too small
- Increase under "*Output*" th entry "*Pulse output all*" so that max. one pulse per second is outputted.

? E110

- Span between relay switching points too small
- Increase the distances between the relay switching points

? E111

- Relay switching points interchanged
- Change relay switching points for "On/Off"

9.3 Instrument repair

If it is necessary to repair VEGAMET 625 please proceed as follows:

You can download a return form (23 KB) from our homepage www.vega.com under: "*Services – Downloads – Forms and Certificates – Repair form*".

By doing this you help us carry out the repair quickly and without having to call back for needed information.

- Print and fill out one form per instrument
- Clean the instrument and pack it damage-proof
- Attach the completed form and possibly also a safety data sheet to the instrument.
- Send the instrument to the respective address of your agency. In Germany to the VEGA headquarters in Schiltach.

10 Dismounting

10.1 Dismounting procedure

**Warning:**

Before dismounting, be aware of dangerous process conditions such as e.g. pressure in the vessel, high temperatures, corrosive or toxic products etc.

Take note of chapters "*Mounting*" and "*Connecting to power supply*" and carry out the listed steps in reverse order.

10.2 Disposal

VEGAMET 625 consists of materials which can be recycled by specialised recycling companies. We have purposely designed the electronic modules to be easily separable. Mark the instrument as scrap and dispose of it according to government regulations (electronic scrap ordinance, ...).

Materials: see "*Technical data*"

If you cannot dispose of the instrument properly, please contact us about disposal methods or return.

11 Supplement

11.1 Technical data

General data

Series	module unit with plug-in socket for mounting on carrier rail 35x7.5 acc. to EN 50022
Dimensions	W = 72 mm (2.83 in), H = 118.5 mm (4.66 in), D = 134 mm (5.28 in)
Weight	approx. 500 g (1.10 lbs)
Housing materials	Noryl SE100, Lexan 920A
Socket materials	Noryl SE100, Noryl SE1 GFN3
Screw terminals	max. wire cross section 1.5 mm ²

Power supply

Operating voltage	20 ... 253 V AC/DC, 50/60 Hz
Power consumption	12 VA; 7.5 W (10 VA; 5.5 W with Ex)

Sensor input

Number of sensors	2x VEGA HART sensors
Kind of input (selectable)	
– active input	sensor is powered by VEGAMET 625
– passive input	sensor has own power supply
Measured value transmission	
– HART protocol (Multidrop)	digital for VEGA HART sensors
Terminal voltage	
– non-Ex version	approx. 28 V with 2 sensors (8 mA)
– Ex version	approx. 18 V with 2 sensors (8 mA)
Current limitation	approx. 45 mA (approx. 26 mA with Ex)
Adjustment range HART sensor	
– Adjustment range	±10 % of sensor measuring range
– min. adjustment delta	0.1 % of sensor measuring range
Connection cable	2-wire screened standard cable

Relay outputs

Quantity	3x operating relay, 1x fail safe relay
Function	Switching relay for level or pulse relay for flow/ sampling pulse
Contact	floating spdt
Contact material	AGSNO2 hard gold-plated
Turn-on voltage	min. 10 mV DC, max. 250 V AC/DC
Switching current	min. 10 µA DC, max. 3 A AC, 1 A DC
Breaking capacitance	min. 50 mW, max. 750 VA, 18 W with U = 60 V DC; 40 W with U ≤ 40 V DC
min. programmable switching hysteresis	0.1 %

Current outputs

Quantity	3 outputs
Function	Current output for level or for flow/sampling pulse
Range	0/4 ... 20 mA; 20 ... 0/4 mA
Resolution	1 µA
Max. load	500 Ohm
Fault signal	0; 3.6; 4; 20; 20.5, 22 mA (adjustable)
Linearity error	0.08 % (relating to 20 mA)
Temperature error	0.005 %/K (relating to 20 mA)
Mode pulse output	
– Load	min. 600 Ohm
– Voltage pulse	12 V DC with 20 mA
– Pulse length	200 ms

Ethernet interface

Quantity	1x, cannot be combined with RS232
Data transmission	10/100 Mbit
Plug connection	RJ45

RS232 interface

Quantity	1x, cannot be combined with Ethernet
Plug connection	RJ45 (modem connection cable on 9-pole D-SUB in the scope of delivery)

Displays

Measured value indication

- | | |
|---|--------------------------------------|
| – graphic-capable LC display (50x25 mm), background lightning | digital and quasianalogue indication |
| – max. indicating range | -99999 ... 99999 |

LED displays

- | | |
|---|---------------|
| – status indication operating voltage | 1x LED green |
| – Status indication fault signal | 1x LED red |
| – Status indication operating relay 1-3 | 3x LED yellow |
| – Status indication interface activity | 1x LED green |
-

Adjustment

- | | |
|---------------------|--|
| Adjustment elements | 4x keys in the front for menu adjustment |
|---------------------|--|
-

Ambient conditions

- | | |
|-----------------------------------|--------------------------------|
| Ambient temperature | -20 ... +60°C (-4 ... +140°F) |
| Storage and transport temperature | -40 ... +80°C (-40 ... +176°F) |
-

Electrical protective measures

- | | |
|---------------------------|-------|
| Protection instrument | IP 30 |
| Protection plug-in socket | IP 20 |
| Overvoltage category | II |
| Protection class | II |
-

Electrical separating measures

Reliable separation acc. to VDE 0106 part 1 between power supply, sensor input and digital part

- | | |
|-------------------------|---------|
| – Reference voltage | 250 V |
| – insulation resistance | 3.75 kV |

Galvanic separation between relay output and digital part

- | | |
|-------------------------|-------|
| – Reference voltage | 250 V |
| – insulation resistance | 4 kV |

Potential separation between Ethernet interface and digital part

- | | |
|-------------------------|------|
| – Reference voltage | 50 V |
| – insulation resistance | 1 kV |

Potential separation between RS232 interface and digital part

- | | |
|-------------------------|------|
| – Reference voltage | 50 V |
| – insulation resistance | 50 V |

Approvals¹⁾

ATEX II (1) GD, [Ex ia] IIC

¹⁾ Deviating data with Ex applications: see separate safety instructions.

11.2 Dimensions

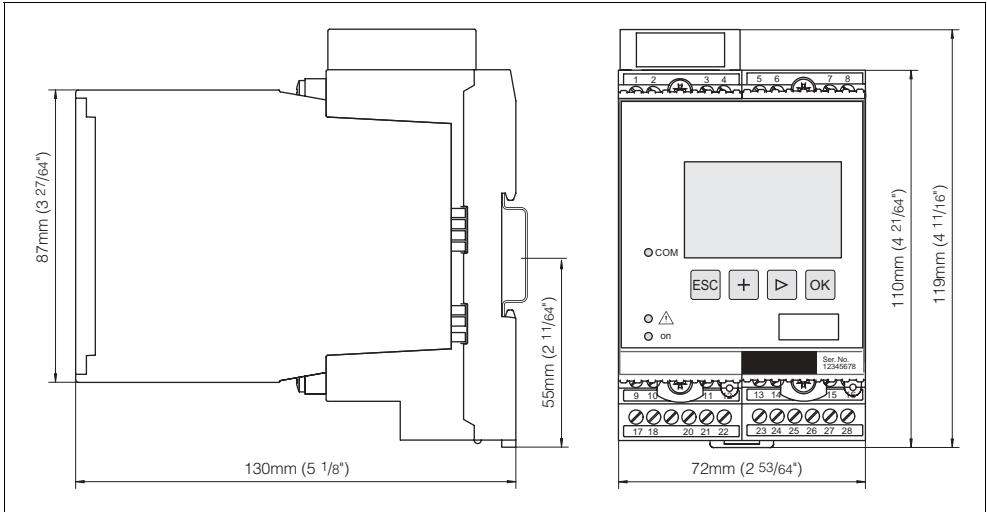

Fig. 12: Dimensions VEGAMET 625

11.3 Certificate

CE declaration of conformity

CE

Konformitätserklärung

Declaration of conformity
Déclaration de conformité

VEGA^Δ

VEGA, Grieshaber KG
Am Hohenstein 113
77761 Schiltach

erklärt in alleiniger Verantwortung, daß das Produkt / déclare under
our sole responsibility that our product / déclare sous sa seule
responsabilité que le produit

VEGAMET 624, VEGAMET 625

auf das sich diese Erklärung bezieht, mit den folgenden Normen
Übereinstimmt / to which this declaration relates is in conformity
with the following standards / auquel se réfère cette déclaration
est conforme aux normes

Emission / Emission / Emission → EN 61326 / A1 : 1998 (Klasse A)
Immision / Susceptibility / Immision → EN 61326 : 1997 / A1 : 1998
EN 61010 – 1 : 2001

gemäß den Bestimmungen der Richtlinien / following the provision
of Directives / conformément aux dispositions des Directives

7323 EWG
89036 EWG

Schiltach, 14.07.2004



Josef Fehrenbach
Entwicklungsleitung

Fig. 13: CE declaration of conformity



VEGA Grieshaber KG
Am Hohenstein 113
77761 Schiltach
Germany
Phone +49 7836 50-0
Fax +49 7836 50-201
E-mail: info@de.vega.com
www.vega.com



All statements concerning scope of delivery, application, practical use and operating conditions of the sensors and processing systems correspond to the information available at the time of printing.